

## SOLANO VT LVTER

2 LEG | 2 MOTOR | C-LEG with Programmable Remote

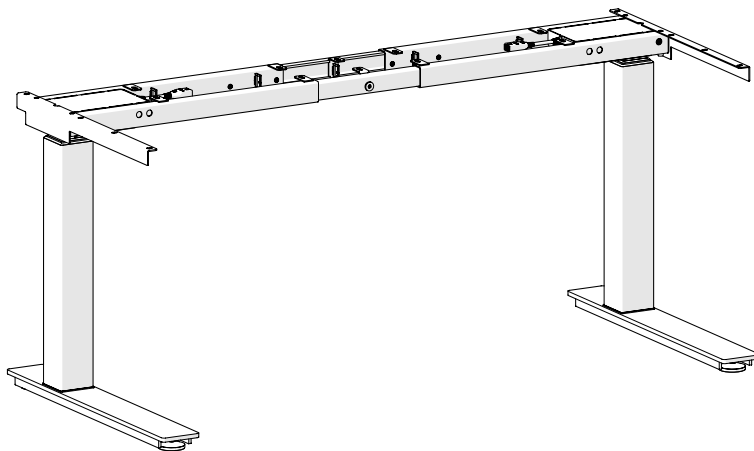

## 1. Packaging

### 1.1 Part Check List

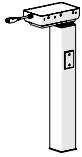

Leg (2 Pcs)

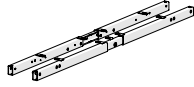

Top Frame (2 Pcs)

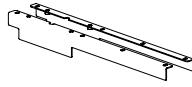

End Pipe (2 Pcs)

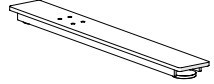

Feet (2 Pcs)

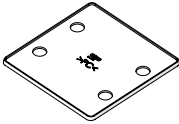
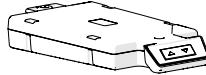

Plate (2 Pcs)



Cable Clamp (10 Pcs)



Smart Control Unit (1 Pcs)

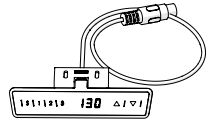

Remote Control (1 Pcs)

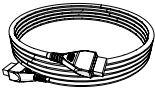

Motor Cables (2 Pcs)

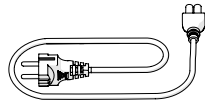

Power Cable (1 Pcs)

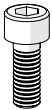

M6x16 (26 Pcs)



M6x10 (8 Pcs)



M6x40 (4 Pcs)



ST 2.9x16 (2 Pcs)



ST 5.5x16 (20 Pcs)



Parts displayed above may vary, based upon Frame Configuration

## 2. Assembly



Before attempting assembly of the Height Adjustable Frame, please read safety information in Section 2.

### 2.1 Torque Guide

#### Max torque

- M6 Screw's max torque = 6nm
- M8 Screw's max torque = 6nm
- M10 Screw's max torque = 6nm
- **Tapping screws is hand tightening only**

### 2.2 Assembly Step by Step

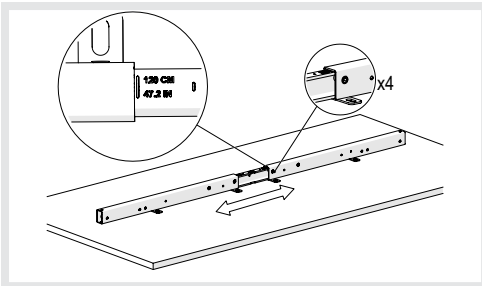

#### Step 1

Adjust frame to suitable length using the scale on the frame and fasten the screws. Make sure the scale is the same on both sides.

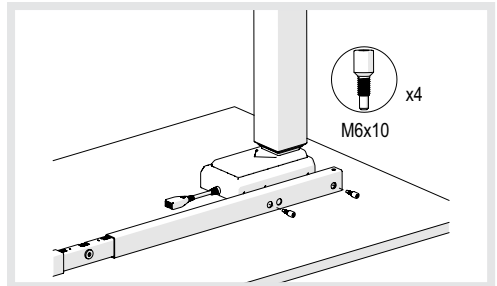

#### Step 2

Assemble the Leg to the Top Frame. Please pay attention to use the suitable hole. Please refer to **Section 2.1 Torque Guide**.

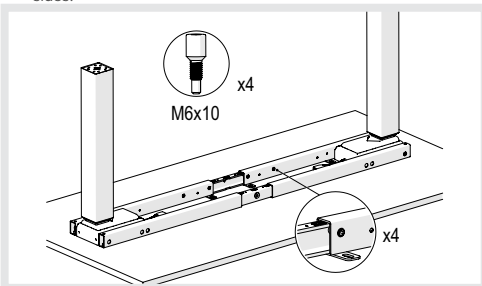

#### Step 3

Assemble the Top Frame and Leg on the other side as illustrated above. Fasten the screws of the Top Frames. Please refer to **Section 2.1 Torque Guide**.

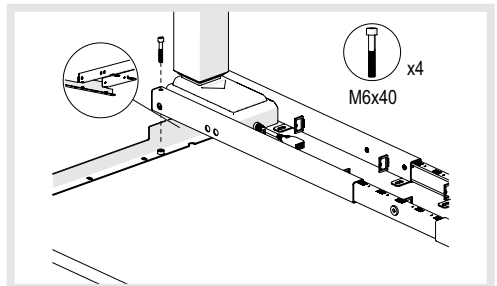

#### Step 4

Assemble the Top Frame and End Pipe as illustrated above. Please refer to **Section 2.1 Torque Guide**.

## 2. Assembly

### 2.3 Assembly Step by Step

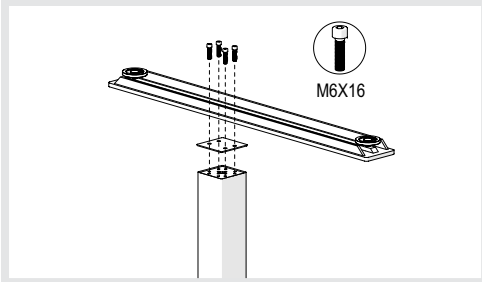

#### Step 5

Assemble the Feet as illustrated above. The smooth side of the plate faces the foot. Please refer to **Section 2.1 Torque Guide**.

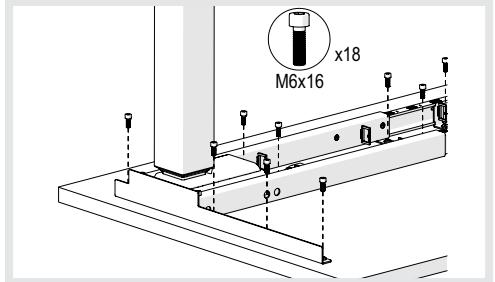

#### Step 6-1 (Use screws M6X16)

Mount the Frame to the Table top and fix the Top Frame as illustrated above. Please refer to **Section 2.1 Torque Guide**.

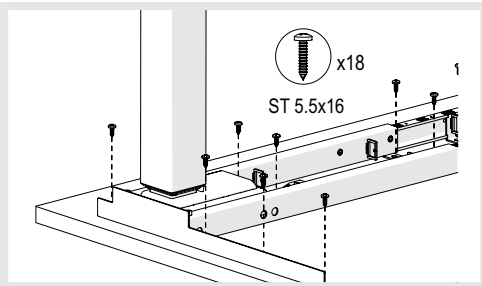

#### Step 6-2 (Use screws ST 5.5X16)

Mount the Frame to the Table top and fix the Top Frame as illustrated above. Please refer to **Section 2.1 Torque Guide**.

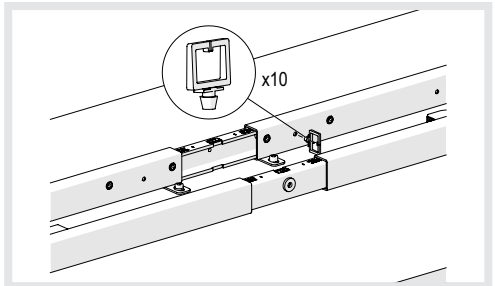

#### Step 7 (Optional)

Insert the cable clamp into the hole on the frame.

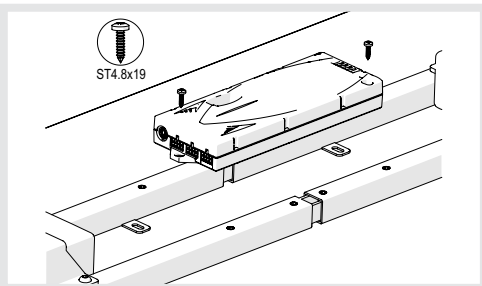

#### Step 8

Mount the Control Unit as illustrated above. Please refer to **Section 2.1 Torque Guide**.

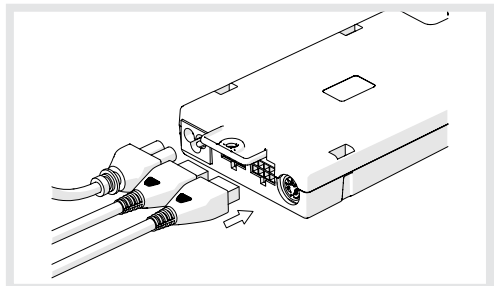

#### Step 9

Connect the Motor and Power Cables to the Control Unit as illustrated above.

## 2. Assembly

### 2.4 Assembly Step by Step

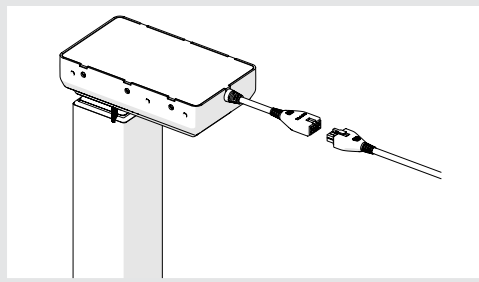

#### Step 10

Connect the Motor Cable to the Leg as illustrated above.

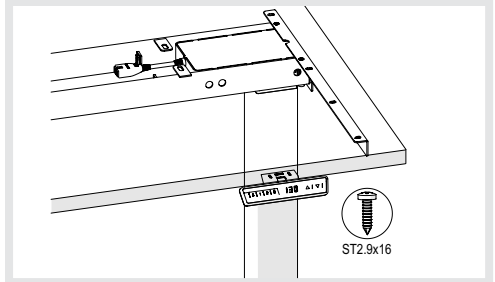

#### Step 11

Mount the Remote Control to the Table top as illustrated above. Please refer to **Section 2.1 Torque Guide**.

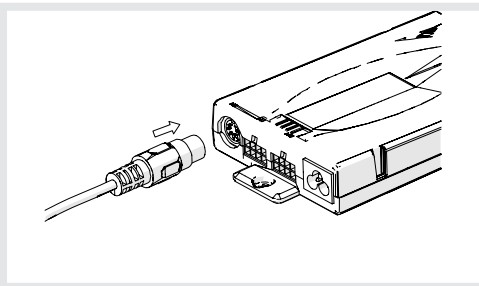

#### Step 12

Connect the Remote Control Cable to the Control Unit as illustrated above.

### 2.5 Zero Setting:

When you use the height adjustable frame for the first time or you wish to use a configured control unit on another identical electric height adjustable frame, you must reset the lowest desktop position to the minimum height.

- Press ▼ button and keep pressing it until the desktop has reached the lowest position (programmed desktop position).
- Press ▼ button again and keep pressing it. After about 5 seconds, the desktop will slowly move further down until it reaches the absolutely lowest desktop position possible.
- Release ▼ button. The electric height adjustable frame can now be used.